

Products > Jewel Bearings > Vee Jewels > V1.20

# Vee Jewels - V1.20

## Specifications

<b>Model</b>	V1.20
<b>Outside Diameter</b>	.0469/.0472"
<b>Thickness</b>	.0374/.0394"
<b>Radius</b>	.002/.0031"
<b>Angle</b>	75/85°
<b>Vee Depth</b>	.0138/.0177"



### Description

Vee Jewels are well suited to sensitive instruments where the moving element is light. They offer minimum friction when used with conical, small radiused pivots and permit slight lateral movement. The jewel radius should be 3 times larger than the pivot radius for low friction torque, sensitivity, and resistance to deformation. The contact area of the pivot should be highly polished and a micro-inch finish of 2 or better on the pivot radius is recommended.

### Typical Applications

- Ohmmeters
- Voltmeters
- Gauges and other Indicating Meters
- Compass
- Timers and Relays

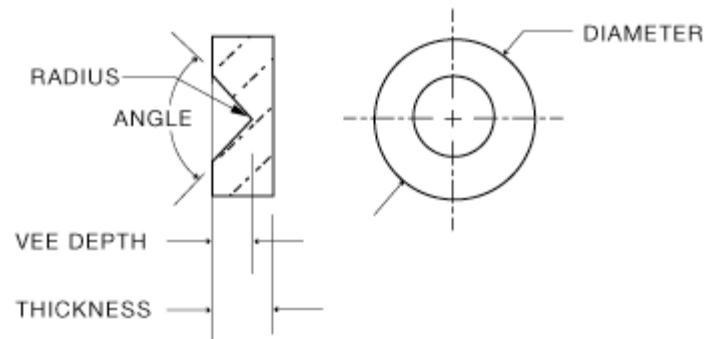

### NOT SEEING EXACTLY WHAT YOU NEED?

We specialize in creating a wide range of custom optical components and custom mechanical components including a variety of shapes - from internal holes and tapers to outer flanges, angles and surface finishes. Contact us and we will consult with you to create a custom component that meets all of your specifications.

